



Installation Guide & User Manual

PERSONAL PA System 500

Narrow-Band FM Wireless Listening System

Transmitter Model T20
Receiver Model R19/*, R19-4A, R19-6

 **Williams Sound**[®]
Helping People Hear



PERSONAL PA SYSTEM 500

Installation and User Manual

Contents	Page
Overview	4
Narrow-Band Basics	5
Controls and Features	6
System Set-Up and Operation	8
Antenna Connection	
Power Connection	
Audio Connection	
Using a Microphone	
T20 Audio Processor Options	
Using R19/R19-4/R19-6 Receivers	
Adjusting Receiver Tone Controls	
Battery & Charger Information	
Receiver Management Suggestions	14
Using a Remote Antenna	15
Troubleshooting Guide	16
Radio Interference / Tuning Instructions	18
Warranty	19
System Specifications	20

Overview

Thank you for purchasing the Personal PA System 500 from Williams Sound Corp. The PPA System 500 is a Narrow-Band FM Listening System which operates in the 72-76MHz frequency band. Designed for hearing assistance in places of public access, the PERSONAL PA System 500 is for those who need help overcoming background noise, reverberation, or distance from the sound source. The versatile PPA 500 is easily integrated with your existing sound system or can be used with a microphone as a stand-alone system.

Your PPA System 500 has two principal parts: the T20 Transmitter and the R19, R19-4, or R19-6 Receivers. Much like a miniature radio station, the transmitter and microphone pick up the sounds you want to hear and broadcast them over an FM radio signal. The receivers are used to pick up the broadcast up to 500 feet away.

To avoid difficulties, please read through this manual as you begin to use the system. Then save it for questions that arise as you continue to use your PERSONAL PA System 500.

If you have any problems with this Williams Sound product, don't hesitate to call us toll-free at 1-800-843-3544.

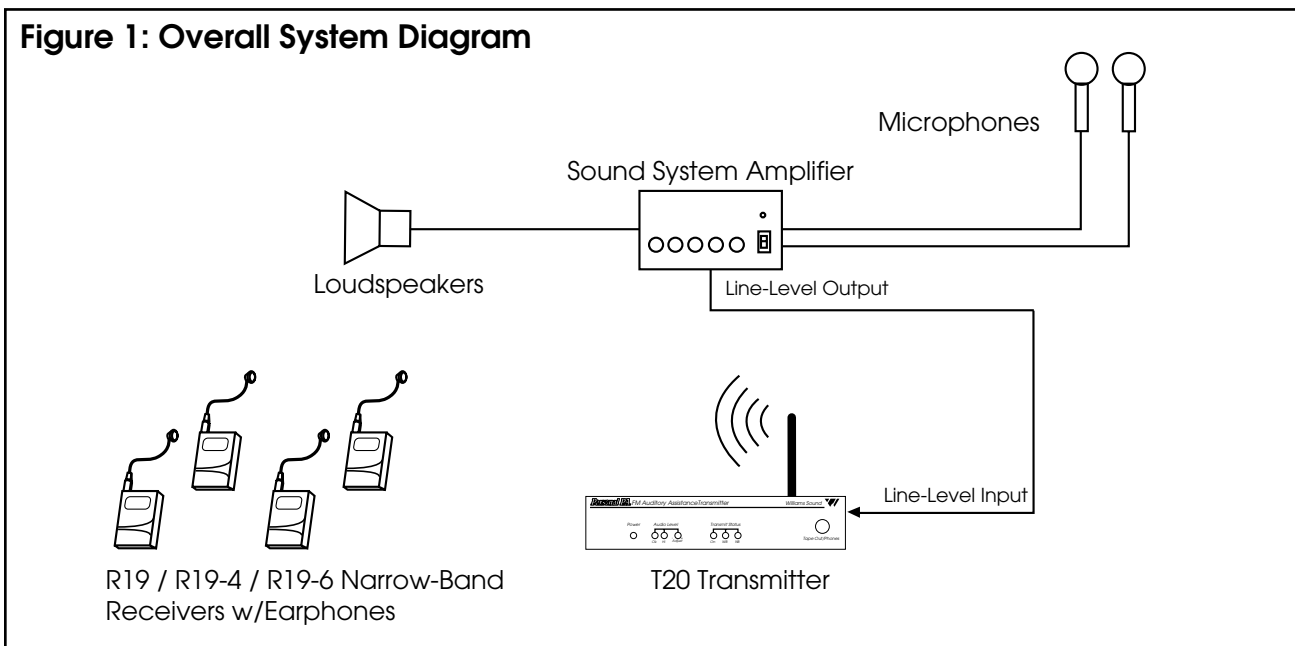

Narrow-Band Basics

Less Interference

All FM receivers are tuned to a specific carrier frequency. The selectivity of the receiver determines how close nearby radio signals can be to this carrier frequency before interference occurs. True narrow-band receivers like the Williams Sound R19 use dual-conversion circuitry to achieve a very narrow “window” of acceptance for radio signals. This allows them to operate in areas that have a lot of different radio signals with less likelihood of receiving interference.

More Simultaneous Channels

This narrow window of acceptance means more channels can be squeezed into the designated frequency band. Instead of dividing the Auditory Assistance Band (72-76MHz) into 10 wide channels (wide-band), the same band can be divided into 40 closely spaced (narrow-band) channels. The selectivity of the R19 dual conversion receiver allows you to operate on these closely-spaced channels without interference from the next channel.

Greater Operating Range

Another measure of FM receiver performance is sensitivity, measured by the weakest radio signal that the receiver can respond to and still operate properly. All hearing assistance transmitters are limited by FCC Rules to the same transmitted signal strength, so you can't boost transmitter power or antenna efficiency to get more operating distance. The farther you move from the transmitting antenna, the weaker the signal becomes. A very sensitive receiver like the R19 will allow greater operating distance. Because of its excellent operating distance, the PPA System 500 can be used in situations where maximum coverage area is needed.

Sound Quality

Narrow-band systems give up some frequency response (extended highs and lows) and noise performance compared to wide-band systems. This is usually not a drawback for spoken word presentations, but may not be optimal for programs which are primarily music.

Manufacturers often list a minimum signal strength needed to maintain an acceptable noise level in the receiver before it “squelsches” or goes quiet. The Williams Sound R19 receiver is designed to offer maximum sensitivity with minimum noise and a reasonable squelch action.

Overload Protection

Making a receiver sensitive for greater reception of weak signals can create a problem when the receiver is used in an area that has strong radio signals. Unless the receiver has a superior dynamic range, it can be overloaded by the strong signal and become noisy, distorted, or vulnerable to interference. The Williams Sound R19 receiver uses state-of-the-art circuitry for improved RF dynamic range.

Capture Effect

When an FM receiver is presented with two radio signals on the same channel, it will “lock on” to whichever signal is stronger. This is called the “capture effect.” Because signal strength is related to distance, this usually means that the closest transmitter antenna will produce the strongest signal and “capture” the receiver.

Controls and Features

Receiver Model R19

EAR Jack

Mono 3.5 mm mini earphone jack

Off/On Indicator Light

Red LED which indicates receiver is “on” when lit. If the batteries are near end of life and the LED turns off while the receiver is operating, approximately one hour of battery life remains.

Tone Control

3-position switch which cuts low frequencies at certain thresholds: (Lo: 20 Hz, Mid: 120 Hz, Hi: 700 Hz)

Volume/On-Off Control

Combination volume and on-off rotary control.

Channel Slide Switch

2-position slide switch used to alternate between two pre-set narrow-band frequencies. Standard channels are 33 and 53. See page 18 for instruction on changing system frequencies.

Transmitter Model T20

See Figures 3 and 4.

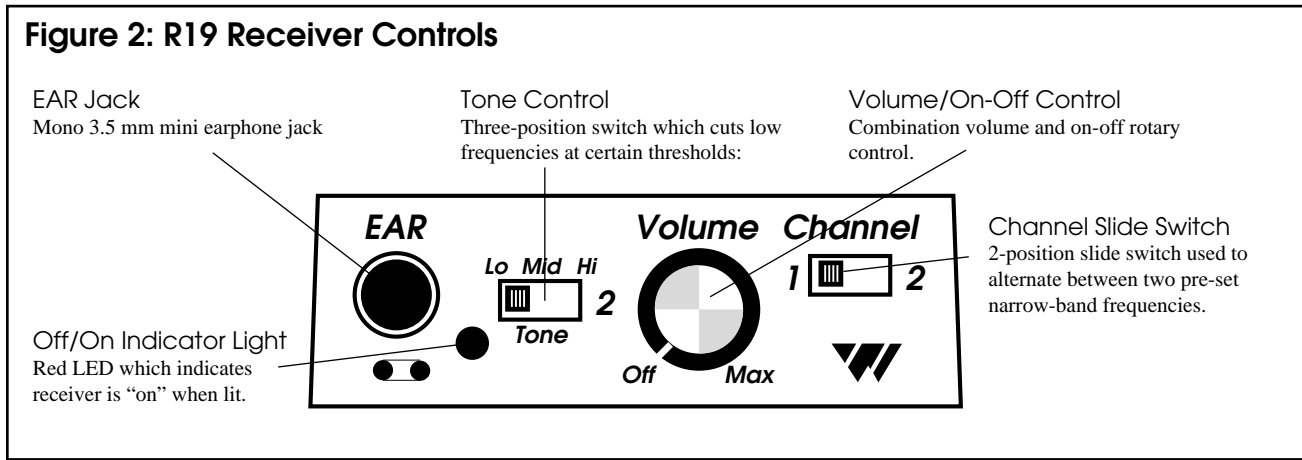

Figure 3: T20 Front Panel Controls & Features

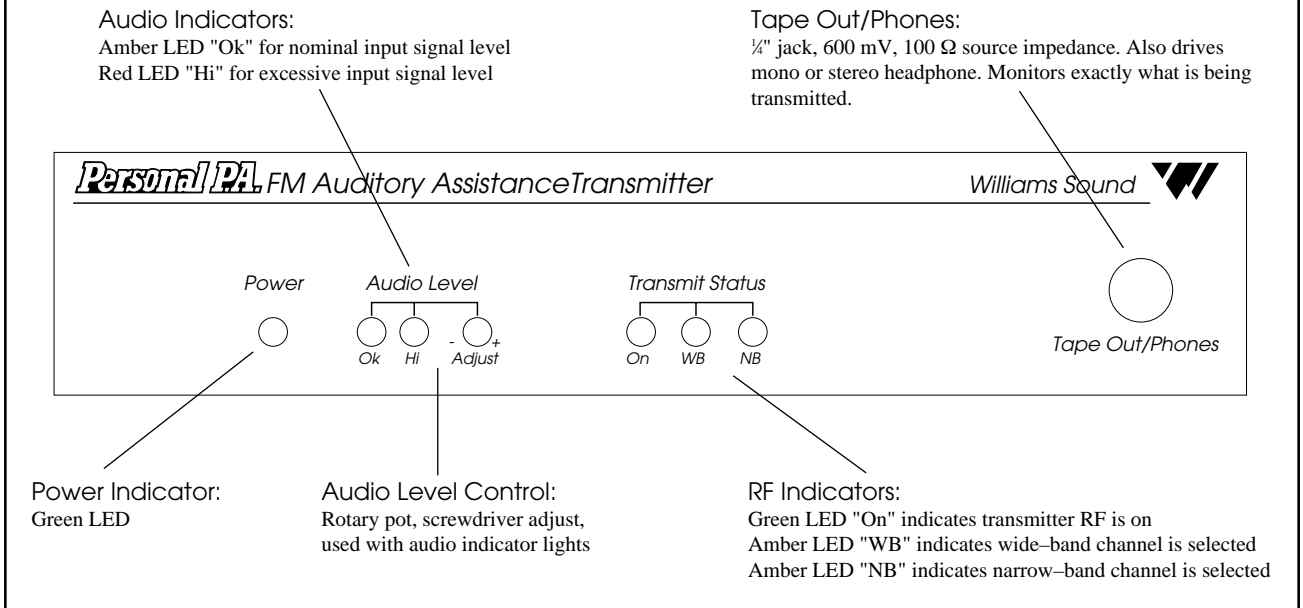
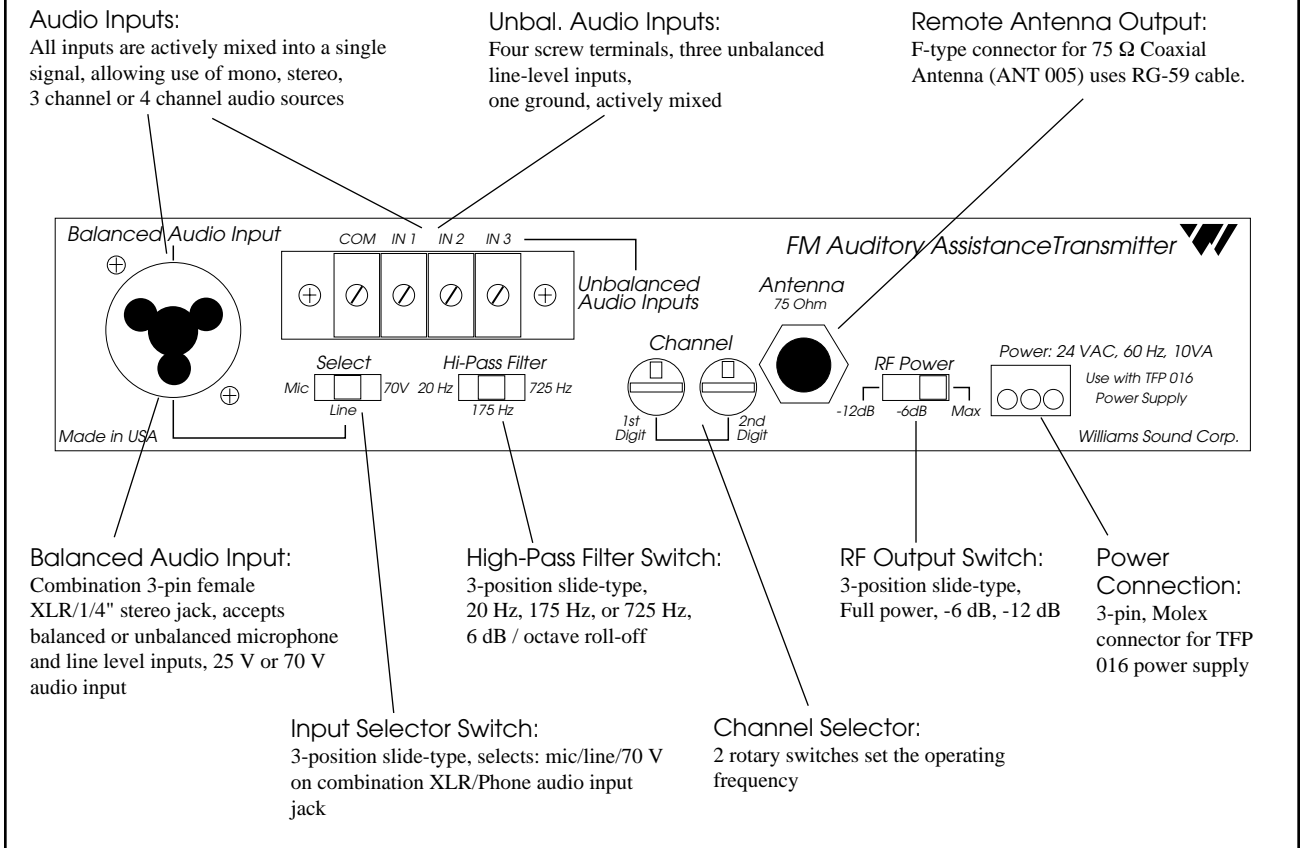

Figure 4: T20 Rear Panel Controls & Features



Set-up & Operation

T20 Transmitter

Step 1: Install the antenna.

The “rubber duck” whip antenna fits into the hole on top of the transmitter and threads onto a mounting stud inside. Guide the antenna onto the stud and turn it clockwise to tighten. Do not use excessive force to tighten the antenna. It only needs to be finger-tight.

If the optional remote antenna (ANT 005) is more appropriate, contact your dealer or Williams Sound Corp. The remote antenna installation is detailed on page 15.

Step 2: Connect the Transmitter to Power.

The T20 is supplied with a wall transformer power supply (TFP 016). Plug the power cord into the “Power” connector on the rear panel of the T20. Then plug the transformer into a 120 V, 60 Hz wall outlet. The indicator light on the front panel of the T20 should glow when the power is connected.

There is no ON/OFF switch. Due to low energy consumption, the T20 is designed to run continuously.

The wall transformer can be plugged into a switched outlet that turns on when the other sound equipment is turned on. If turning the T20 on creates a hum or buzz in the sound system, see the Troubleshooting Guide on page 16.

Step 3: Make audio connections.

Step 3a: (If you will be using the T20 with an existing sound system)

Refer to the Overall System Diagram, on page 4. The T20 has been designed to accept virtually any type of audio input, with up to four different input signals actively mixed together. The best sources for audio signal from sound system are as follows:

- 1st Choice: TAPE OUT or LINE OUT
- 2nd Choice: BOOSTER or BRIDGING
- 3rd Choice: Speaker Terminal, or Speaker Transformer tap

Input connection options for the T20 transmitter are as follows:

Balanced Audio Input Concentric Jack:

1. Accepts balanced and unbalanced XLR or TRS 1/4" Mic-Level or Line-Level Inputs
2. Accepts balanced and unbalanced Mic-Level or Line-Level Inputs
3. Accepts balanced and unbalanced Speaker-Level Inputs (25V, 70V speaker line)

See Figure 6 for connection details.

Use the audio cable and adaptor supplied to connect the T20 “Audio In” jack to an appropriate audio output jack on the sound system mixer or amplifier. (See Figure 4.)

If your amplifier or mixer does not have RCA-type connectors, you can obtain adaptors from your Authorized Williams Sound Dealer or a local radio parts store.

Figure 5: Using The Audio Cable Supplied With The System

From Sound System Line Output

To T20 Concentric Jack

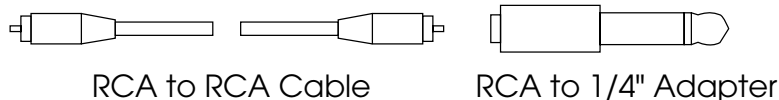
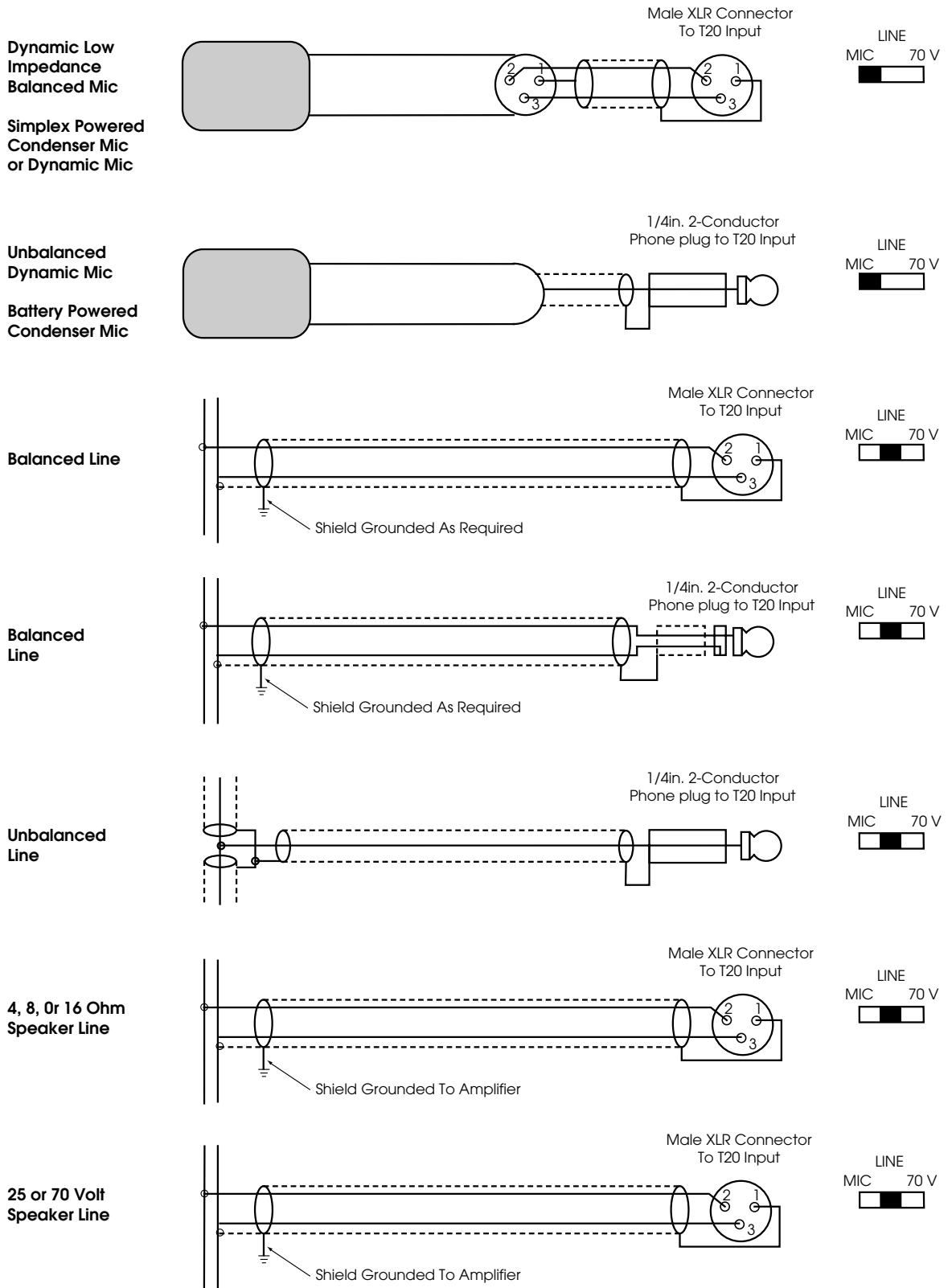

Figure 6: Audio Connection Wiring Detail



If the TAPE OUT jack is already in use, a Y-Cord can be used to connect the T20 and a second device to the same jack.

Unbalanced Audio Input Terminals:

Accepts one to three unbalanced line-level signals, which are actively mixed. The three inputs share a common ground connection.

Step 3b: (If you will be using the T20 with a microphone as a stand-alone system)

Plug the microphone into the concentric jack (“Balanced Audio Input”) on the rear panel of the T20. The T20 supplies positive DC voltage to power condenser microphones per DIN45596. (Standard dynamic microphones may also be used.) Make sure the input selector switch is in the MIC position. Talking into the microphone should cause the audio indicator light to flash on the front panel. If you use both the Microphone input and the Audio Input on the T20, the signals will be mixed.

Step 4: Set the Input Selector Switch.

If you are using the combination XLR/phone plug input jack, make sure the selector switch is set in the proper position as shown in Figure 6.

Step 5: Set the Hi-Pass Filter Switch.

The High-Pass Filter switch is used to reduce low frequencies. It is normally used in the middle (175 Hz) position to provide high frequency emphasis that improves speech understanding for hard of hearing listeners. If the program content is primarily musical, it can be used in the left (20 Hz) position. The right position (725 Hz) may be used for further low frequency reduction, or it may be used to reduce low frequency system noise due to pick up of ventilation system noise, etc.

Step 6: Set the RF Power Switch.

In some situations, the radio signal produced by the transmitter can enter other types of equipment and create a hum or buzzing sound in the sound system. This is due to poor RF protection in the other equipment, NOT a problem with the transmitter.

The normal switch position is MAX power (right).

If you encounter a hum or buzz in the sound system when the T20 is turned on, move the switch to the -6 dB (middle position). If the buzz diminishes, but persists, move the switch to the -12 dB (left) position. If this does not solve the problem, refer to the Troubleshooting Guide on page 16.

However, if the amount of buzz does not change when the RF power switch is moved from MAX to -12 dB, the buzz is not related to RF interference from the T20.

The system range is decreased when power is reduced, but usually still covers the entire seating area.

Step 7: Use a receiver to test the system and set the input level control.

Figure 7: T20 Audio Processor Performance

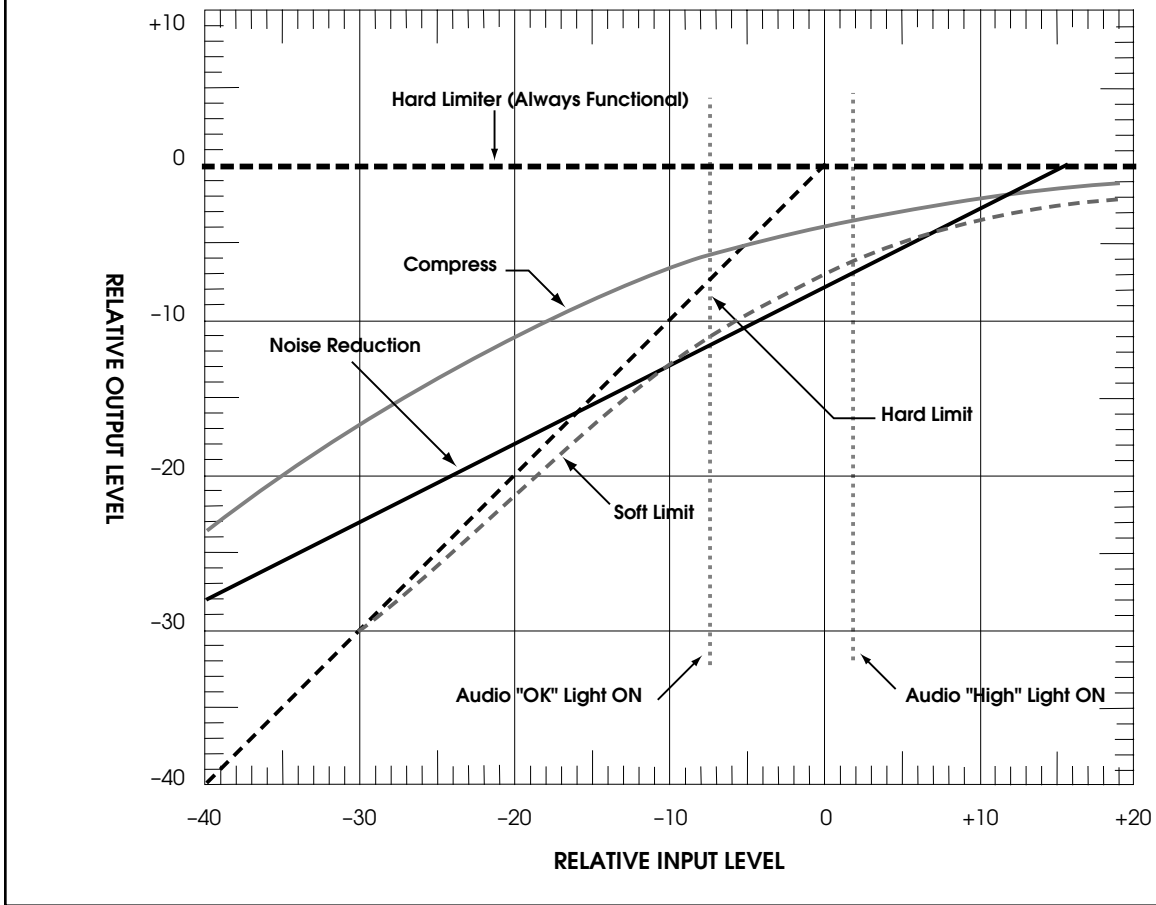

Audio Processor Options

The audio processor in the T20 is capable of four modes of operation. The effects of these modes are charted in figure 7.

Compressor Mode

Compressor mode is used for hearing assistance to limit the dynamic range of the audio signals. Hearing impaired people generally have a reduced tolerance for wide dynamic range. The T20 is shipped in Compressor Mode.

Noise Reduction Mode

The T20 can also be configured for for 2:1 compression. This is for use only with a receiver that has a 2:1 expansion circuit for noise reduction. Noise reduction is typically used in narrow-band operation for high quality audio.

Soft Limit Mode

The T20 can also operate in a soft limit mode, which allows full dynamic range of audio signals. This mode may be preferred for musical programs, but may provide too much dynamic range for hearing impaired listeners.

Hard Limit Mode

Hard Limit Mode is useful if the T20 has been installed with external signal processing.

For assistance in selecting an alternate audio processing mode, contact Williams Sound technical assistance at 1-800-328-6190.

R19 / R19-4 / R19-6 Receivers

Step 1: Install the batteries.

Pry open the battery compartment door with a coin. Press the batteries into place, observing proper battery polarity. **Do not force the batteries in backwards!**

Step 2: Plug the earphone or headphone into the earphone jack.

Step 3: Turn the receiver on by turning the volume control clockwise. Turning the knob clockwise will increase the volume. Turning the knob counter-clockwise will decrease the volume. To avoid draining the battery, make sure the receiver is turned off when not in use.

Step 4: If you are using the PPA System 500 with an existing sound system, make sure the sound system is turned on. Have someone speak into a microphone while you listen with the receiver and earphone. You should be able to hear their voice through the receiver.

If you are using the PPA System 500 with its own microphone, have someone speak into the microphone while you listen with the receiver and earphone. You should be able to hear their voice through the receiver.

Step 5: The T20 Transmitter has a screwdriver-adjusted input level control located on the front panel to compensate for different input signal levels. Adjust the control so the “OK” audio light flashes with the signal. It’s alright if the “HI” light comes on occasionally. Reduce the signal level by turning the control counter-clockwise if the “HI” light is on all the time.

If the “OK” light does not come on at all, turn the T20 input level control clockwise to increase the signal. If the input level control is fully clockwise and the “OK” light still does not come on, you will need to increase the signal level at its source (mixer or P.A. amplifier).

Note: The earphone cord is the receiving antenna. Do not bunch up the cord, wrap it around the receiver, or place the receiver in a shirt pocket. The cord should hang as straight as possible.

Step 6: If you don’t hear the signal in the receiver, try moving the R19 channel selector switch to the other channel. The R19-4 features a four-channel selector knob preset to channels 13, 23, 33, and 53. R19-6 features a six-channel selector knob preset to channels 13, 23, 33, 38, 43, and 53. Turn the selector knob until you hear the desired program.

Adjusting The Receiver Tone Controls

The R19, R19-4, and R19-6 allow adjustments to cut low frequency sounds. Use the three-position slide switch on the receiver control panel to make this adjustment.

Battery & Charger Information

Alkaline Batteries

In normal use, two BAT 001 heavy-duty, AA alkaline batteries will last 90-100 hours. If the sound becomes weak or distorted, replace the battery. **The indicator light may still be on, even with a battery that is weak.** Do not leave dead batteries in the receivers.

Rechargeable Batteries

The receivers can also use a rechargeable batteries. We recommend only the BAT 026 AA Ni-Cad battery. These batteries will last about 45-50 hrs per charge.

Batteries from other suppliers may provide shorter operating life.

Figure 8: Using The Optional CHG 200A Battery Charger

- Step 1:** Plug the CHG 200's power supply into the Power Jack on the back of the unit and a standard AC wall outlet.
- Step 2:** Wrap the power cord around the Cord Hook (See figure at right.) This will minimize strain on the cord and jack and insure that the power cord is not detached during charging.
- Step 3:** Make sure the receivers to be charged are turned OFF.
- Step 4:** Place the receivers in the slots so that the CHG 200's Charging Pins and receiver's side panel contacts are coupled. Make sure that the charging contact holes line up with the charging pins. The receivers should drop easily into the slots. **DO NOT FORCE THEM IN BACKWARDS.**
- Step 5:** The Charging Indicators will light, indicating that charging is in process.
- It takes about 14 hours to fully charge the batteries. Remove the receivers when charging is completed.**

Further Suggestions

Receivers **SHOULD NOT** be left charging continuously when not in use. Receivers should always be turned OFF while charging.

It's best to allow the batteries to fully discharge before charging.

If the batteries are near end of life and the LED turns off while the receiver is operating, this is an indication to change or recharge your batteries. Approximately one hour of battery life remains.

Repeatedly charging the batteries after short periods of use (1-2 hours) will shorten battery life.

Rechargeable batteries will need to be replaced after 1-2 years of use.

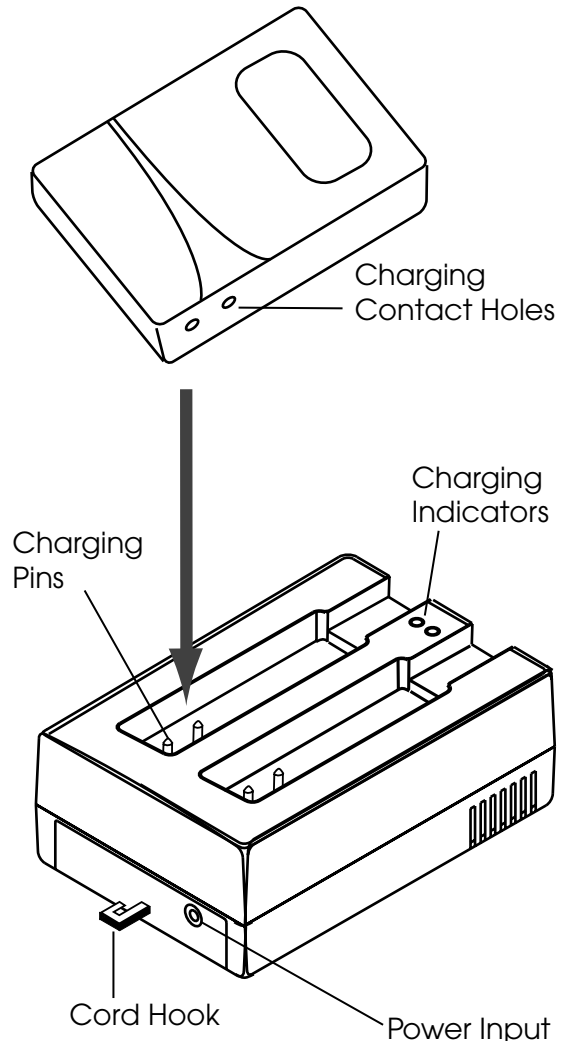

**!! WARNING !!
DO NOT ATTEMPT TO RECHARGE
DISPOSABLE BATTERIES!**

The batteries may heat up and burst, causing possible injury and damage to the equipment.

***terminals together with metal objects. Battery damage and burns can result!**

Use only Williams Sound supplied chargers and batteries!



Suggestions For Receiver Management

Different types of facilities will use different approaches for receiver management and earphone sanitation. Below are some options that customers have used successfully.

1. Regular users purchase their own receiver and take care of their own batteries and earphone.
2. Some facilities label the receiver and earphone with the names of regular users so each person uses the same receiver and earphone.
3. Ushers issue receivers to people who request them. Earphones are sanitized after use. Foam ear cushions can be replaced or washed with a mild detergent, rinsed thoroughly and air-dried. The EAR 022 Surround Earphone can be sanitized with an alcohol pad.
4. The receivers can be stored in a multiple compartment storage case with a credit card or driver's license left as collateral for the receiver.

Using A Remote Antenna

The optional ANT 005 Coaxial Antenna is intended for use with rack-mounted transmitters or in installation areas where a remote antenna is needed for maximum operating distance.

Per FCC Rules, only antennas supplied by Williams Sound may be used with this transmitter.

Do not cut or alter the antenna cable before reading the instructions below!

The ANT 005 Coaxial Antenna is a length of coaxial cable with an "F" connector on one end and an 80-inch antenna built onto the other end. The last 80 inches of the antenna make up the active element, which is covered by nylon braid. **The active element should never be altered.** The remainder of the antenna cable is RG-59 coax feedline. The feedline can be shortened if you have the tools to install a new F-connector. If you need a longer feedline, extension cables are available from Williams Sound in 50 foot lengths (WCA 008 50). Never splice coax cables together. Always use proper connectors.

Installing The Remote Antenna

- Step 1:** Remove the "rubber duckie" antenna from the T20's top panel by turning it COUNTER-CLOCKWISE.
- Step 2:** Use a pliers to remove the cap on the connector. Be sure to turn COUNTER-CLOCKWISE to remove the cap.
- Step 3:** The ANT 005 Coaxial Antenna connects to the "Antenna" connector on the rear panel of the T20 Transmitter. To attach the cable, making sure the center wire on the cable enters the hole in the center of the receptacle. The connectors screw together and need only be "finger-tight."

Remote Antenna Location Guidelines

For maximum signal strength, it is best to select an antenna location somewhere within the listening area. The preferred location is towards the front of the listening area and above the seats. The active element (nylon braid covered portion) should be kept straight, not coiled, and must be vertical.

Radio signals will generally pass through non-metal structures. The antenna can be mounted on a wall, in a corner, or behind a wooden beam. It may also be hung vertically from the ceiling, with a small weight attached to the end to make it hang freely. If you need to run the feedline through a wall, a 1/2" hole is necessary to pass the connector through.

Avoid placing the antenna within four feet of steel beams or near structural steel elements. Metal studs, ductwork, and foil-backed insulation can absorb radio energy, greatly reducing the range of the system. DO NOT put the active element (last 80 inches) inside a metal conduit. The feedline is categorized as Class II wiring. Thus, it may be (but is not required to be) routed through metal conduit, but NOT with microphone cables or AC power wiring.

Nylon clamps and screws are provided to attach the Coax Antenna to a wall. Locate the clamps every 3 - 4 feet. DO NOT bend the cable sharply at any point. Allow at least a 3" radius for turns. DO NOT staple the cable in place. Use the cable clamps provided or hang the antenna from the excess nylon braid at the end of the antenna element.

Troubleshooting Guide

For most efficient troubleshooting, use high quality headphones to monitor the quality of the signal being fed into the T20. Plug them into the “Tape Out/Phones” jack on the T20

Transmitter “Power” light not on.

1. Make sure the wall transformer is plugged into the transmitter correctly.
2. Make sure the electrical outlet is on.

No sound through receivers.

1. Try switching to the other channel on the R19.
2. If some of the receivers work, but others don't, check for bad batteries or earphones on the receivers that aren't working. Check to see that those receivers' frequencies match the transmitter frequency. The R19 is preset for channels 33 and 53.
3. If none of the receivers work, check to see if the power is connected to the transmitter and the “Power” light is on. Check to see if the transmitter and receivers are set on the same frequency. Look at the two channel switches on the T20's rear panel, checking the settings against the chart on top of the T20. The standard channels for the R19 are 33 and 53.
4. Check to see if the Transmitter is connected properly to the sound system. See page 8.
5. Turn the screwdriver-adjust input level control located on the T20 front panel clockwise to increase the input signal strength until the audio indicator light flashes.
6. If you are not using an input signal from a sound system, make sure the microphone is plugged into the “Mic” jack on the rear of the T20 transmitter and the input selector switch is in the MIC (left) position.

7. Make sure the antenna is installed and connected properly. See pages 8 or 15.

Sound through receivers is excessively loud and is distorted.

1. The T20 transmitter is probably set to a wide-band channel. Select a narrow-band channel.

Sound is of normal volume. “HI” audio light not continuously on, but sound is distorted.

1. The source audio might be distorted.
2. Input select switch might be in wrong position. Try other positions.

Too much noise when talking stops. Normal sound compressed excessively. Red “HI” light lit too frequently.

1. Turn audio adjust counter-clockwise. Red “HI” light should blink only occasionally. Audio “OK” light should be on when there is normal audio present.
2. Consider changing the audio processor option. The T20 is shipped in Compress Mode. See page 11 for details.

Sound through the receivers is weak and noisy.

1. Turn the screwdriver-adjust input level control located on the T20 front panel clockwise to increase the input signal strength until the audio indicator light flashes. The audio fed into the T20 may be noisy or weak. Use a headphone in the Phones jack on the front of the T20 to listen to the input signal. If it is weak and noisy from the phones jack, turn up the appropriate mixer control or try a different audio source.

- 
2. Increase the input signal level from the sound system by turning up a mixer control.
 3. Make sure a valid narrow-band channel is selected and make sure the transmitter and receivers are tuned to the same channel.

Buzzing or humming noise in sound system.

1. Most likely, there is nothing wrong with the T20 transmitter. One or more pieces of equipment in the sound system are being disturbed by RF (Radio Frequency) signals produced by the T20. The most likely suspects are your amplifier, mixer, or tape deck. The RF gets into the other equipment primarily through the power cord, speaker wires, or unshielded inputs, all of which can act as antennas.

Try moving the “RF Power” switch to the –6dB or –12dB position. This will reduce the system range somewhat.

2. If remedy 1 does not solve the problem, we recommend using the optional Coax Antenna (ANT 005), which should be located 15-20 feet away from the other sound equipment. You may add additional RG-59 feedline as needed.
4. If changing to the Coax Antenna doesn't help, it's time to dig deeper into the problem. This involves a slight modification to the equipment causing the problem. Unless you have the necessary technical skills, this is best left to a qualified electronics repair technician. Call your Authorized Dealer or Williams Sound Corporation for more information. Ask for the Buzz Paper.

Tuning Instructions

The PERSONAL PA System 500 is usually not disturbed by other radio services. However, there are no clear or exclusive channels for this radio service. One of the unique features of the PPA System 500 is that the operating frequency can easily be changed to an alternate channel in the field to avoid interference.

Basic Frequency Change Procedure

Step 1: If you are experiencing interference on channel 33, try channel 53 as your first alternate. Set the T20's channel selector switches to channel 53. (See Figure 9.)

Step 2: Change all Receiver frequencies to receiver channel 53.

For the R19, move the slide switch on the control panel to channel 2

For the R19-4 and R19-6, turn the rotary switch on the control panel to channel 4.

Transmitter Frequencies

Channels are changed using the T20's two rotary "Channel" selector switches. One of the 10 standard narrow-band channels must be selected for use with the R19 series Receivers.

The wide-band channels are available for use with Williams Sound's line of wide-band receivers, including the R7, R7-4, R7-6, and R16.

Receiver Frequencies

The R19 has a slide switch to select from channels 1 or 2 (channels 33 and 53).

The R19-4's rotary switch allows you to select between channels 1-4, (channels 13, 23, 33, and 53).

The R19-6's rotary switch allows you to select between channels 1-6, (channels 13, 23, 33, 53, 38, and 43).

Make sure the transmitter frequency matches the receiver frequency.

Figure 9: T20 Channel Selection

Wide-Band Channels

1st Digit	2nd Digit	Freq (MHz)	CH
0	0	NA	NA
0	1	72.100	A
0	2	72.300	B
0	3	72.500	C
0	4	72.700	D
0	5	72.900	E
0	6	75.500	F
0	7	75.700	G
0	8	75.900	H
0	9	74.700	I
1	0	75.300	J

Narrow-Band Channels

1st Digit	2nd Digit	Freq (MHz)	CH
1	1	72.025	11
1	2	72.075	12
1	3	72.100	13
1	4	72.125	14
1	5	72.175	15
1	6	72.225	16
1	7	72.275	17
1	8	72.300	18
1	9	72.325	19
2	0	72.375	20
2	1	72.425	21
2	2	72.475	22
2	3	72.500	23
2	4	72.525	24
2	5	72.575	25
2	6	72.625	26
2	7	72.675	27
2	8	72.700	28
2	9	72.725	29
3	0	72.775	30
3	1	72.825	31
3	2	72.875	32
3	3	72.900	33
3	4	72.925	34
3	5	72.975	35
3	6	74.625	36
3	7	74.675	37
3	8	74.700	38
3	9	74.725	39
4	0	74.775	40
4	1	75.225	41
4	2	75.275	42
4	3	75.300	43
4	4	75.325	44
4	5	75.375	45
4	6	75.425	46
4	7	75.475	47
4	8	75.500	48
4	9	75.525	49
5	0	75.575	50
5	1	75.625	51
5	2	75.675	52
5	3	75.700	53
5	4	75.725	54
5	5	75.775	55
5	6	75.825	56
5	7	75.875	57
5	8	75.900	58
5	9	75.925	59
6	0	75.975	60
61 - 99		NA	NA

Note: NA = Not Available



The R19, R19-4, and R19-6 operate on fixed crystals. Because of the nature of these crystals, frequency tuning is highly stable over the life of the receiver.

Crystals are not tunable. if alternate frequencies are needed, return the receivers to your dealer for new crystals. There are 10 standard frequencies available.

Warranty

The Williams Sound T20 Transmitter, R19, R19-4, and R19-6 Receivers are warranted against defects in workmanship and materials for FIVE YEARS. Microphones, earphones, cables, carry cases, rechargeable batteries and chargers are warranted against defects in workmanship and materials for NINETY DAYS. This warranty does not extend to intentional or accidental physical damage. This warranty applies only to products returned to Williams Sound for service. To return a product for service, call 1-800-843-3544 and request a Return Authorization (RA) number.

PPA T20 TRANSMITTER SPECIFICATIONS

PERSONAL PA Transmitter Model T20

Dimensions, Weight: 8.45" (21.5 cm) W x 8.18" (20.8 cm) D x 1.72" (4.4 cm) H, 3lbs. (1.5 kg)
Color: Black epoxy paint with white legends
Rack Mount: One IEC rack space high, one or two units can be mounted in a single rack space with optional RPK 005 (single) or RPK 006 (double) Rack Mount Kits
Power: External power supply(TFP 016), 24 VAC, 50 or 60 Hz, 10 VA, 230 mA max. current drain
FCC ID: CNMT20
Operating Freqs: 72-76 MHz, 10 wide-band and 10 narrow-band channels,
Stability: ±.005% stability, 0-50° C
Deviation: ± 75 kHz max. for wide-band channels, ± 5 kHz max for narrow-band channels
Pre-Emphasis: Wide-band: 75 µsec, narrow-band: 300 µsec
RF Field Strength: 8000 µV/m at 30 m max., 20 mW typical
Nominal Range: 300-500 ft. (90-150 m)
AGC Options: (1) standard variable slope compressor/limiter (2) Noise Reduction (3) Soft Limit (4) Hard Limit
Frequency Response: WB: 30 Hz - 15 kHz ±3 dB, .25% Max. THD NB: 30 Hz - 5 kHz ±3 dB, .25% Max. THD
Signal to Noise Ratio: 50 dB with PPA R19 Receiver

Front Panel:

Power Indicator: Green LED
RF Indicators: Green LED "On" indicates transmitter RF is on
Amber LED "WB" indicates wide-band channel selected
Amber LED "NB" indicates narrow-band channel selected

Audio Indicators: Amber LED "Ok" for nominal input signal level
Red LED "Hi" for excessive input signal level
Audio Level Control: Rotary pot, screwdriver adjust, used with audio indicator lights
Tape Output: 1/4" jack, 600 mV, 100 Ω source impedance, also drives mono or stereo headphone

Rear Panel:

Audio Inputs: All inputs are actively mixed into a single signal, allowing use of mono, stereo, 3 channel, or 4 channel audio sources
Balanced Audio Input: Combination 3-pin female XLR/1/4" stereo jack, accepts balanced or unbalanced microphone and line level inputs, 25 V or 70 V audio input Lo-Z, 100 µV min. to 50 mV max. 1 mV nominal, 3 kΩ input impedance Supplies simplex power 20 V (DIN45596) for condenser mics
Mic Input Levels: 21 mV min. to 10 V max., 212 mV nominal, 100 KΩ input impedance
Line Input Levels: 216 mV min. to 100 V max., 2.16 V nominal, 100 KΩ input impedance
70 Volt Input Levels: Four screw terminals, three unbalanced line-level inputs, one ground, actively mixed
Unbal. Audio Inputs: 3-position slide-type, selects: mic/line/70 V on combination XLR/Phone audio input jack
Input Selector Switch: 3-position slide-type, 20 Hz, 175 Hz, or 725 Hz, 6 dB/octave roll-off
High-Pass Filter Switch: 3-position slide-type, Full power, - 6dB, - 12dB
RF Output Switch: Thread Mount for "rubber duckie" flexible whip antenna, optional hard-wired 75 Ω Coaxial Antenna (ANT 005) uses RG-59 cable, 400 ft., (140 m) max. cable length
Antenna Outputs: 3-pin Molex connector
Power Connections: 2 rotary switches set the operating frequency
Channel Selector:

Recommended Receivers

PERSONAL PA Receivers: Model R19*, Model R19-4*, Model R19-6*

Model PPA R19:	2-Channel, Pre-Tuned, Selectable CH 33 (72.9 MHz), CH 53 (75.7 MHz) standard 10 Channels Available (72.1-75.9 MHz)	FCC ID: CNMR19 Earphone: Earbud-type with foam cushion, 3.5 mm plug, mono, 32 Ω
Model PPA R19-4:	4-Channel, Pre-Tuned, Selectable CH 13 (72.1 MHz), CH 23 (72.5 MHz), CH 33 (72.9 MHz), CH 53 (75.7 MHz)	Output Connector: 3.5 mm mini phone jack, mono FM Deviation: Narrow-band, 5 kHz De-Emphasis: 300 µs
Model PPA R19-6:	6-Channel, Pre-Tuned, Selectable CH 13 (72.1 MHz), CH 23 (72.5 MHz), CH 33 (72.9 MHz), CH 53 (75.7 MHz) CH 38 (74.7 MHz), CH 43 (75.3 MHz)	Sensitivity: 0.7 µV at 12 dB Sinad Squelch Level: 4 µV for minimum 40 dB S/N ratio Frequency Response: 100 - 5 kHz, ± 3 dB (Tone: Lo) Receiver Antenna: Integral with earphone cord Signal-to-Noise Ratio: 50dB Audio Output: 35 mW, max. at 16 Ω (Tone: Lo; 3 VDC Bat.) Acoustic Output: 125 dB Max SSPL90 with EAR 013
Dimensions:	3-5/8" L x 2-3/8" W x 7/8" H (92.1 mm x 60.3 mm x 22.2 mm)	
Weight:	3.2 oz (90 g) with battery	
Color:	Neptune Blue	
Battery Type:	(2) BAT 001 AA Alkaline or (2) BAT 026 Ni-Cad	
Battery Drain:	20 mA, nominal	
Battery Life:	90-100 hrs with 2 AA Alkaline 45-50 hrs/charge with BAT 026	
Operating Freq:	Crystal controlled. See factory for frequency changing instructions.	
Intermediate Freqs:	10.7 MHz, 455 kHz	

*NOTE: Specific receiver model numbers contain a frequency code. For example, Model R19/33/53 is preset to channels 33 and 53. The R19 and R19-4 Receivers are crystal-controlled for optimal stability. If the standard R19 or R19-4 channels cannot be used, the receiver must be returned to the factory for alternate crystals.